



MODERN  FLAMES

ELECTRIC FIREPLACE
2019 PRODUCT CATALOG



MODERN FLAMES

ABOUT US

Modern Flames was established in 2008 and has quickly become the innovative leader in contemporary electric fireplace design and technology. After pioneering the linear electric fireplace throughout North America, Modern Flames' brand has skyrocketed with many firsts to market which include; the first linear recessed electric fireplace, the first fully built-in electric fireplace, the first outdoor electric and now the first steam electric fireplace. Modern Flames' products have gained notoriety with architects, designers, builders and homeowners for its unbelievable life-like flame appearance,

ease of installation and affordable cost to the builder compared to wood and gas. With global movement into greener building and high efficiency products, Modern Flames' new FusionFire™ technology allows consumers to achieve the look of a fireplace without sacrificing the realism of a real fire. With a new corporate headquarters and expanded warehouse in Phoenix, Arizona, along with it's new steam technology, Modern Flames continues to be a leader in the electric fireplace industry. Modern Flames is innovating the industry standards of tomorrow.

CONTENTS

- 4-7** Ambiance CLX2 Series
Framed Recessed Wall Mount Electric Fireplace
- 8-11** Landscape FullView 2 Series
Electric Fireplace with Unique Frameless Design
- 12-15** Landscape Pro Slim Series
Electric Fireplace with Unique Frameless Design

- 16-19** Landscape Pro MultiView Series
Built-in Clean Face Electric Fireplace
- 20-23** Spectrum Linear Series
Linear Electric Fireplace with 12 Flame Colors
- 24-27** Spectrum Conventional Series
Conventional Electric Fireplace with 12 Flame Colors

- 28-31** Sedona Series
Built-in Flush Mount Electric Fireplace
- 32-33** Sunset Charred Oak Logs
Electric Log Set - Li-ion Battery or Plug-in
- 34-35** ZCR2 Series
Electric Fireplace Insert



AL60CLX2-G

AMBIANCE CLX2 SERIES













Recessed or Wall Mount Electric Fireplace

The popular Ambiance CLX2 electric fireplace offers the ultimate combination of versatility and design. This award winning, upgraded product series has an improved look offering simple customization. The Ambiance CLX2 features a NEW color changing orange to blue flame for year-round use, a thermostat for setting that ideal temperature and includes 2 styles of media for 2 distinctive looks: coals and glacier diamond glass. Four unique surround options offer the ultimate customization: stainless steel, black stainless steel, flat white metal & matte black metal. The 45" and 60" sizes are the perfect addition to any room in the home.



AL80CLX2-G

STANDARD FEATURES

-  Recessed or Wall Mount Installation
-  Color Changing Orange to Blue Flame
-  Media - Coals & Glacier Glass (Included)
-  Low Energy LED Flame Technology
-  Unsurpassed Realistic Flame Pattern
-  Hi-tech Touch Screen Controls
-  New Sleek Remote
-  Can be Installed Beneath a TV
-  Variable Heat with Thermostat
-  Variable Flame Controls
-  120 Volt Direct Plug-in
-  Do it Yourself Installation Instructions

AMBIANCE CLX2 SERIES

Available in 5 Linear Widths with More Ways to Customize



Fireplace Height 25.5" with 5 Widths Available: 45" 60" 80" 100" 144"



Orange Flames with Standard Coal Bed Orange Flames with Standard Glacier Glass Ember Bed Blue Flames with Standard Glacier Glass Ember Bed



AL144CLX2

UPGRADE OPTION - HALO BACKLIGHT KIT



Optional 10 Color RGB Halo Backlight - Includes Upgraded Remote



Fuchsia Pink Blue Aqua Turquoise Green Lime Yellow Red



AMBIANCE CLX2 SERIES

Technical Specs



NEW REMOTE CONTROL

Separate controls for on/off variable heat and variable flame.

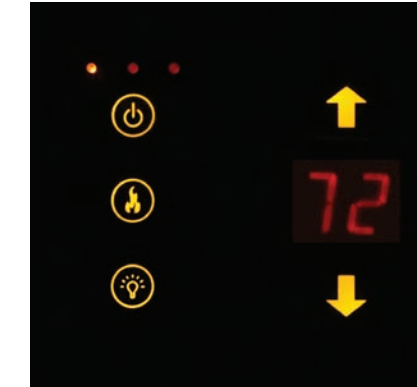

TOUCH SCREEN TECHNOLOGY

A user-friendly series of touch controls operate power, heat (on/off) and light intensity.

Press light intensity for 5 sec. and the flame changes from orange to blue.

The up/down arrows and digital readout indicate and control the temperature setting.

All touch controls fade to black after 4 sec.

With the metal face upgrades you will no longer be able to have the ability to operate the touchscreen on the face of the fireplace. A touchscreen can be mounted in the wall within 3' of the fireplace.

MODEL #	VOLTS	WATTS	BTU's	FRAMING (FINISHED OPENING)	INSTALLATION TYPE
AL45CLX2-G	AC 120V / 60Hz	1,520	5,000	30" L x 19 1/2" H x 4" D	Recessed / Wall Mount
AL60CLX2-G	AC 120V / 60Hz	1,530	5,000	45" L x 19 1/2" H x 4" D	Recessed / Wall Mount
AL80CLX2-G	AC 120V / 60Hz	1,550	5,000	65" L x 19 1/2" H x 4" D	Recessed / Wall Mount
AL100CLX2-G	AC 120V / 60Hz	1,570	5,000	85" L x 19 1/2" H x 4" D	Recessed / Wall Mount
AL144CLX2-G	AC 120V / 60Hz	1,610	5,000	131 1/2" L x 19 1/2" H x 4" D	Recessed ONLY

AL60CLX2 TECHNICAL DRAWING SHOWN

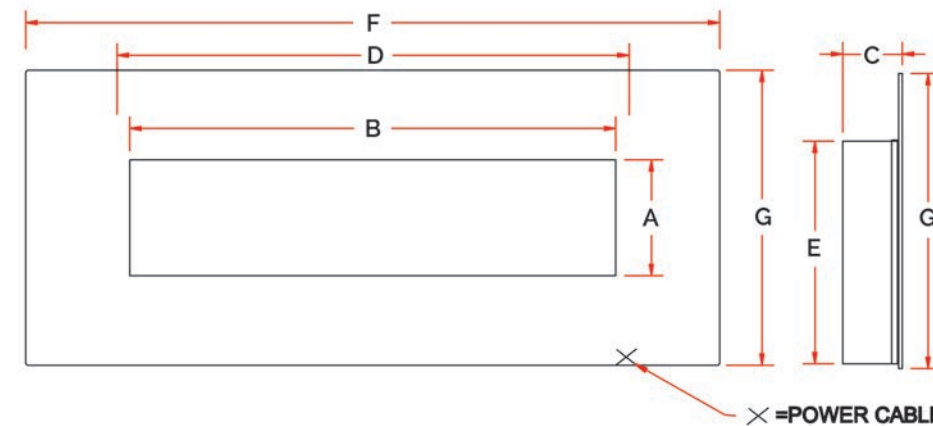

MODEL #	A	B	C	D	E	F	G
AL45CLX2-G	10"	27"	5 1/8"	29 1/4"	19 1/4"	45"	25 1/2"
AL60CLX2-G	10"	42"	5 1/8"	44 1/4"	19 1/4"	60"	25 1/2"
AL80CLX2-G	10"	62"	5 1/8"	64 1/4"	19 1/4"	80"	25 1/2"
AL100CLX2-G	10"	82"	5 1/8"	84 1/4"	19 1/4"	100"	25 1/2"
AL144CLX2-G	10"	126"	5 1/8"	122 1/2"	19 1/4"	144"	25 1/2"













LANDSCAPE FULLVIEW 2 SERIES

Built-in Clean Face Electric Fireplace

The Landscape FullView 2 built-in electric fireplace is the first of its kind creating a perfect substitute for a linear gas fireplace. This unique frameless design allows for edge to edge flame presentation as well as unlimited surround capabilities. Available in 5 different lengths for any application as well as 3 customizable flame bed options for different fit and finishes. An optional 2 stage heater is also included for supplemental heat up to 450 square feet.



STANDARD FEATURES

-  Realistic Natural Flame Appearance
-  Orange/Blue Color Changing Flame
-  Glowing Coal Ember Bed
-  5,000 BTU Heater
-  Full Flame Viewing Area
-  Fully Finished Clean Face Installation
-  Affordable Alternative to Gas
-  Can be Installed Beneath a TV
-  Cool to the Touch with Heat On or Off
-  Remote Control
-  Wall Tether Touch Screen Control

LANDSCAPE FULLVIEW 2 SERIES

Available in 5 Linear Widths with Orange or Blue Changeable Flames



Fireplace Height 15" with 5 Widths Available: 40" 60" 80" 100" 120"



Blue Flames shown with Standard Media – Standard & Dusted w/paint
Orange Flames shown with Standard Media – Standard & Dusted w/paint

MEDIA UPGRADES



LFV2-40/15-SH with DWLS-4015



LFV2-40/15-SH with GC-4015 & BGC-40/15
Can be Ordered Separately



LFV2-100/15-SH

LANDSCAPE FULLVIEW 2 SERIES

Technical Specs



NEW REMOTE CONTROL

Separate controls for on/off variable heat and variable flame.

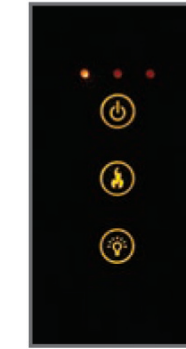

TOUCH SCREEN TECHNOLOGY

Touch control panel can be wall mounted within ten feet of the fireplace. The 3 stacked icons (in order) operate the power, heat (on/off) and light intensity. Hold the light intensity for five seconds to change the flame color from orange to blue. All touch controls fade to black after 4 seconds.

MODEL #	VOLTS	WATTS	BTU's	FRAMING (ROUGH OPENING)	INSTALLATION TYPE
LFV2-40/15-SH	AC 120V / 60Hz	1,530	5,000	55 3/4" L x 12" D x 23" H	Built-In Clean Face
LFV2-60/15-SH	AC 120V / 60Hz	1,530	5,000	75 3/4" L x 12" D x 23" H	Built-In Clean Face
LFV2-80/15-SH	AC 120V / 60Hz	1,550	5,000	95 3/4" L x 12" D x 23" H	Built-In Clean Face
LFV2-100/15-SH	AC 120V / 60Hz	1,600	5,000	115 3/4" L x 12" D x 23" H	Built-In Clean Face
LFV2-120/15-SH	AC 120V / 60Hz	1,600	5,000	135 3/4" L x 12" D x 23" H	Built-In Clean Face

LFV2-60/15-SH TECHNICAL DRAWING SHOWN



MODEL #	A	B	C	D	E	F
LFV2-40/15	15"	40"	11½"	22½"	54¾"	57¼"
LFV2-60/15	15"	60"	11½"	22½"	74¾"	77¼"
LFV2-80/15	15"	80"	11½"	22½"	94¾"	97¼"
LFV2-100/15	15"	100"	11½"	22½"	114¾"	117¼"
LFV2-120/15	15"	120"	11½"	22½"	134¾"	137¼"



Landscape Pro Slim 54"

LANDSCAPE PRO SLIM SERIES











Built-in Clean Face Electric Fireplace

The Landscape Pro Slim built-in electric fireplace is the perfect option for any consumer looking to build in an electric fireplace into any 2 x 6 framed wall. This new Slim model in the Landscape Series features a unique frameless design for a true edge to edge viewing area. A new relocated top mount heater allows for a larger viewing area and new LED light technology give this Slim model a crisp multi-color flame. The Landscape Pro Slim features a 5000 BTU heater, Remote & wireless wall tether control & 4 convenient sizes (42", 54", 66" & 78").



Landscape Pro Slim 54"

STANDARD FEATURES

-  12 Different Flame & Ember Bed Color Options
-  Back Flame & Ember Bed Controlled Independently or Together
-  3 Different Ember Bed Stone Styles
-  Full Flame Viewing Area
-  Fully Finished Clean Face Installation
-  Finish Trim Kit Included
-  5,000 BTU Variable Heater
-  Variable Flames
-  Remote Control
-  Wireless Tether Controls

LANDSCAPE PRO SLIM SERIES

Fireplace Available in 4 Standard Widths



Available in 4 Standard Widths with Stone Ember Bed:

42"

54"

66"

78"



12 Flame Colors - 4 Primary Colors Shown



Comes Standard With 3 Different Types of Stone Media:
Clear, Gray and White



Landscape Pro Slim 54"

LANDSCAPE PRO SLIM SERIES

Technical Specs



REMOTE CONTROL

Separate controls for on/off variable heat and variable flame.



TOUCH SCREEN TECHNOLOGY

Touch control panel can be wall mounted within ten feet of the fireplace. The 3 stacked icons (in order) operate the power, heat (on/off) and light intensity. Hold the light intensity for five seconds to change the flame color from orange to blue. All touch controls fade to black after 4 seconds.

LANDSCAPE PRO SLIM DIMENSIONS

MODEL #	A	B	C	D	E	Framing (WxHxD)
LPS-4214	13 1/2"	42"	6"	23 7/8"	44 1/2"	45"W x 24 1/4"H x 5 1/2"D
LPS-5414	13 1/2"	54"	6"	23 7/8"	56 1/2"	57"W x 24 1/4"H x 5 1/2"D
LPS-6614	13 1/2"	66"	6"	23 7/8"	68 1/2"	69"W x 24 1/4"H x 5 1/2"D
LPS-7814	13 1/2"	78"	6"	23 7/8"	80 1/2"	81"W x 24 1/4"H x 5 1/2"D

LANDSCAPE PRO SLIM 54" DRAWING SHOWN

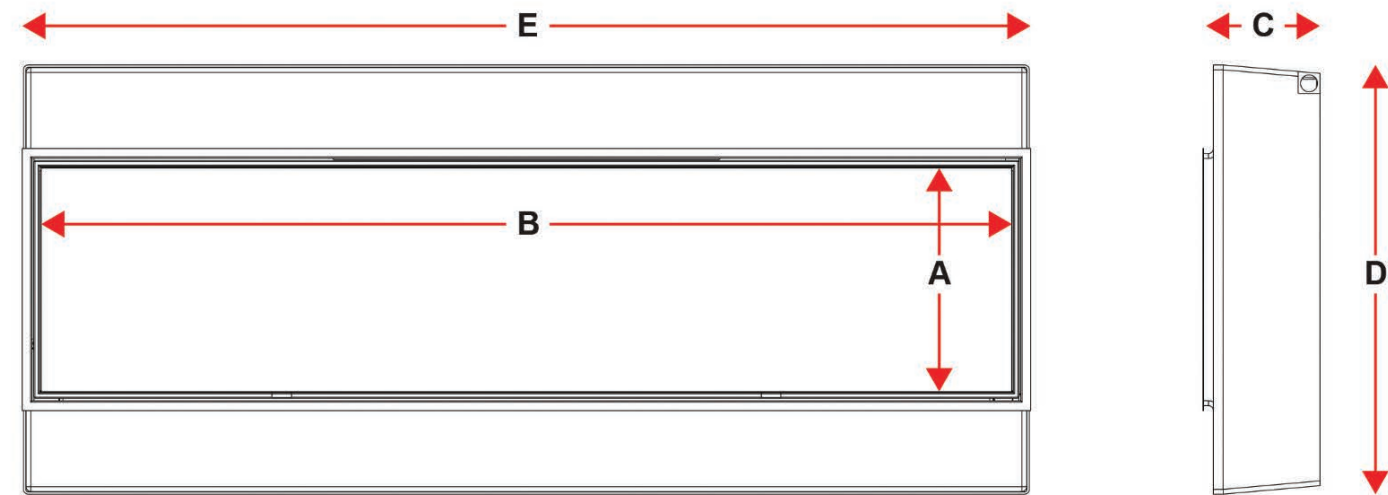



Landscape Pro MultiView 54"

LANDSCAPE PRO MULTIVIEW SERIES













Built-in Clean Face Electric Fireplace

The Landscape Pro MultiView is the industry's first 3-sided customizable length built-in electric fireplace on the market today and comes in 4 standard sizes (42", 54", 66", 78"). With removable side panels, custom installations can now range from a right corner, left corner or bay application with seamless glass edges. The Landscape Pro MultiView features a true edge to edge viewing area for a unique frameless design. A new relocated top mount heater allows for a larger viewing area and new LED light technology give this MultiView model a crisp multi-color flame. The Landscape Pro Multiview also has the ability to be wired 110V for 5,000 BTU heater OR 220V for 10,000 BTU heater & includes 3 different standard media options in the box. An active ember bed gives your media a pulsating effect & unique downlighting allow you to illuminate your logs when the back flame is off. This fully featured built-in electric fireplace is full of customizations & options.



Landscape Pro MultiView 54"

STANDARD FEATURES

-  12 Different Flame and Ember Bed Color Options
-  Back Flame & Ember Bed Controlled Independently or Together
-  8 Different Customizable Sizes
-  Left Corner or Right Corner Bay Installation Types
-  3 Different Ember Bed Stone Styles
-  Full Flame Viewing Area
-  Media Bed Down Lighting
-  Fully Finished Clean Face Installation
-  5,000 or 10,000 BTU Heater Option
-  Variable Flames
-  Remote Control
-  Wireless Tether Controls

LANDSCAPE PRO MULTIVIEW SERIES

Fireplace Available in 4 Standard Widths

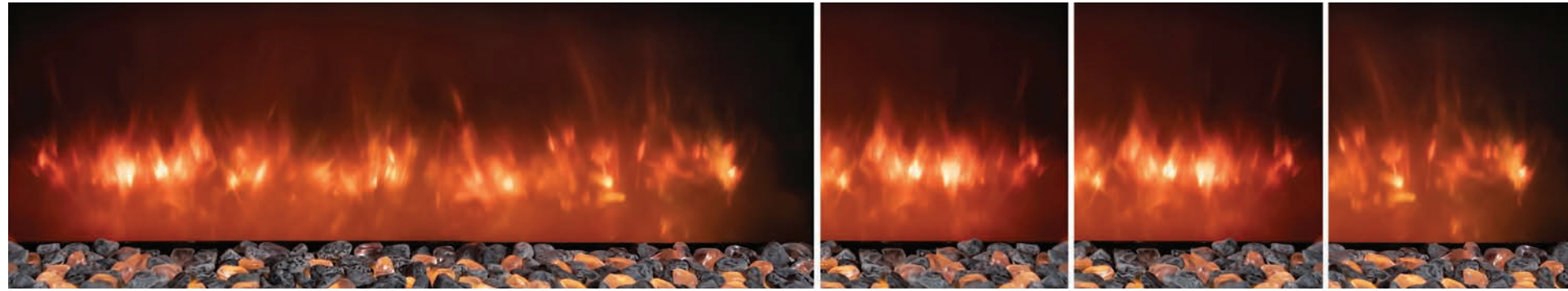

Available in 4 Standard Widths with Stone Ember Bed:

42"

54"

66"

78"



12 Flame Colors - 4 Primary Colors Shown



Comes Standard With 3 Different Types of Stone Media:
Clear, Gray and White



Upgrade Option Driftwood Log Set

LANDSCAPE PRO MULTIVIEW SERIES

Technical Specs



REMOTE CONTROL

Separate controls for on/off, variable heat and variable flame.

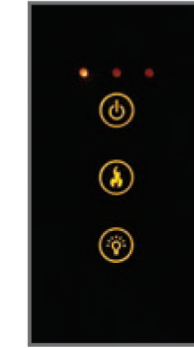

TOUCH SCREEN TECHNOLOGY

Touch control panel can be wall mounted within ten feet of the fireplace. The 3 stacked icons (in order) operate the power, heat (on/off) and light intensity. Hold the light intensity for five seconds to change the flame color from orange to blue. All touch controls fade to black after 4 seconds.

LANDSCAPE PRO MULTIVIEW DIMENSIONS

MODEL #	A	B	C	D	E	Framing (WxHxD)
LPM-4216	15 7/8"	42"	10 1/2"	24 3/4"	44"	44 1/2"W x 25 1/4"H x 10 1/2"D
LPM-5416	15 7/8"	54"	10 1/2"	24 3/4"	56"	56 1/2"W x 25 1/4"H x 10 1/2"D
LPM-6616	15 7/8"	66"	10 1/2"	24 3/4"	68"	68 1/2"W x 25 1/4"H x 10 1/2"D
LPM-7816	15 7/8"	78"	10 1/2"	24 3/4"	80"	80 1/2"W x 25 1/4"H x 10 1/2"D

LANDSCAPE PRO MULTIVIEW 54" DRAWING SHOWN

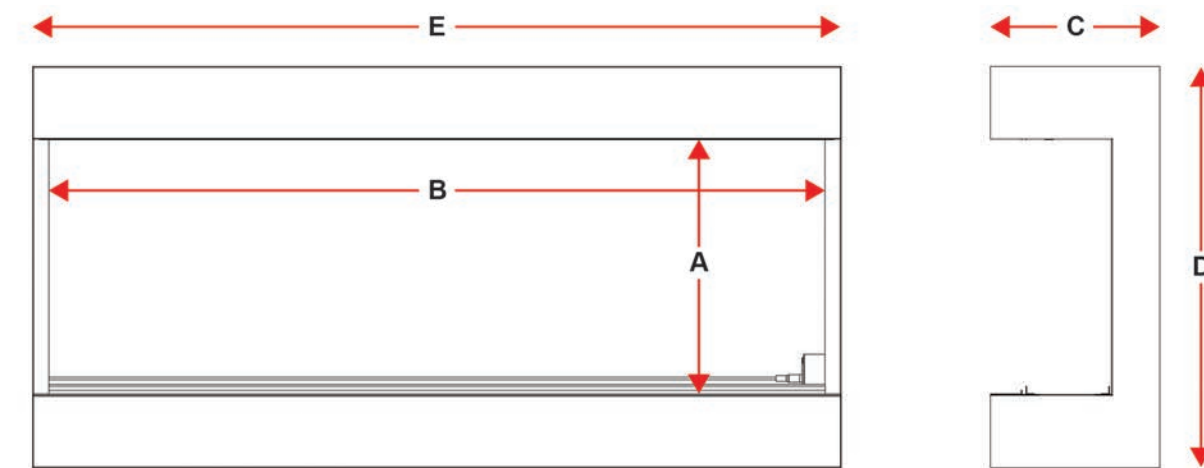



SL50-B

SPECTRUM LINEAR SERIES











Electric Fireplace Built-in Flush Mount

Modern Flames Linear Spectrum Series Built-In Flush Mount Electric Fireplace brings the flame versatility and size options. Our award winning flame appearance now features 12 different flame color combinations to choose from. A gray back screen allows the colors to shimmer and shine, dancing off multicolor glacier diamond glass, creating a crisp, clean flame and contemporary look. Add our realistic Driftwood Logs for a more traditional look. The Spectrum Linear Series is available in 2 different widths: 50" or 74" models. A thermostat, touch control and remote completes this innovative series.



SL74-B

STANDARD FEATURES

-  Unsurpassed Realistic Flame Pattern
-  12 Color Flame Combinations
-  Glacier Glass Ember Bed
-  Low Energy LED Flame Technology
-  Touch Button Controls
-  New Sleek Remote
-  Can be Installed Beneath a TV
-  Variable Heat with Thermostat
-  Variable Flame Controls
-  120 Volt Plug/Hard Wire Ready
-  Do it Yourself Installation Instructions

SPECTRUM LINEAR SERIES

12 Flame Color Combinations at the Push of a Button

The 6 button control panel is located at the top right of fireplace including the digital readout thermostat. Button #1 turns the fireplace on or off. Button #2 turns on the heater. Button #3 turns the heater temperature up and #4 turns the heat down. Button #5 cycles through the 12 different flame color combinations, and button #6 adjusts the flame intensity.



Blue



Cyan



Emerald



Gold

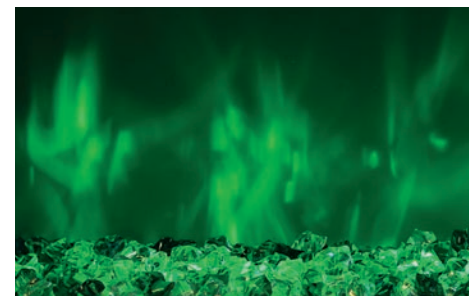

Green



Ice Blue



Magenta



Multi



Orange



Purple

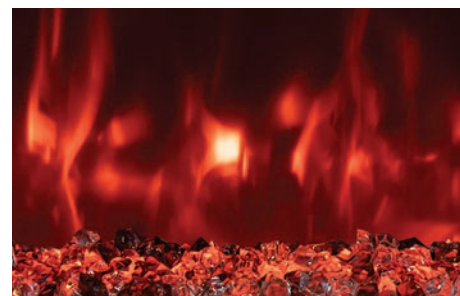

Red

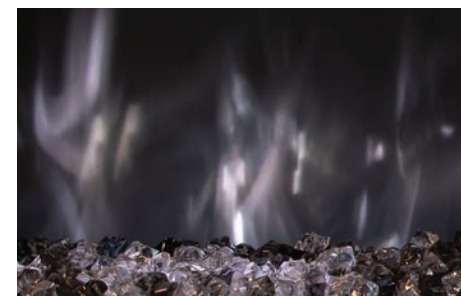

White

Spectrum Linear Upgrade Options



Optional Canyon Driftwood Logs (CDL-50L & CDL-74L)

Spectrum Linear Technical Specs

MODEL #	VOLTS	WATTS	BTU's	FRAMING (FINISHED OPENING)	INSTALLATION TYPE
SL50-B	AC 120V / 60Hz	1,530	5,000	48 1/2" L x 18 1/4" H x 8" D	Fully Recessed
SL74-B	AC 120V / 60Hz	1,530	5,000	72 1/2" L x 18 1/4" H x 8" D	Fully Recessed

MODEL #	A	B	C	D	E	F	G
SL50-B	13 1/4"	46 1/4"	7 5/8"	47 7/8"	18"	49 3/4"	19"
SL74-B	13 1/4"	70 1/2"	7 5/8"	72 1/8"	18"	74"	19"

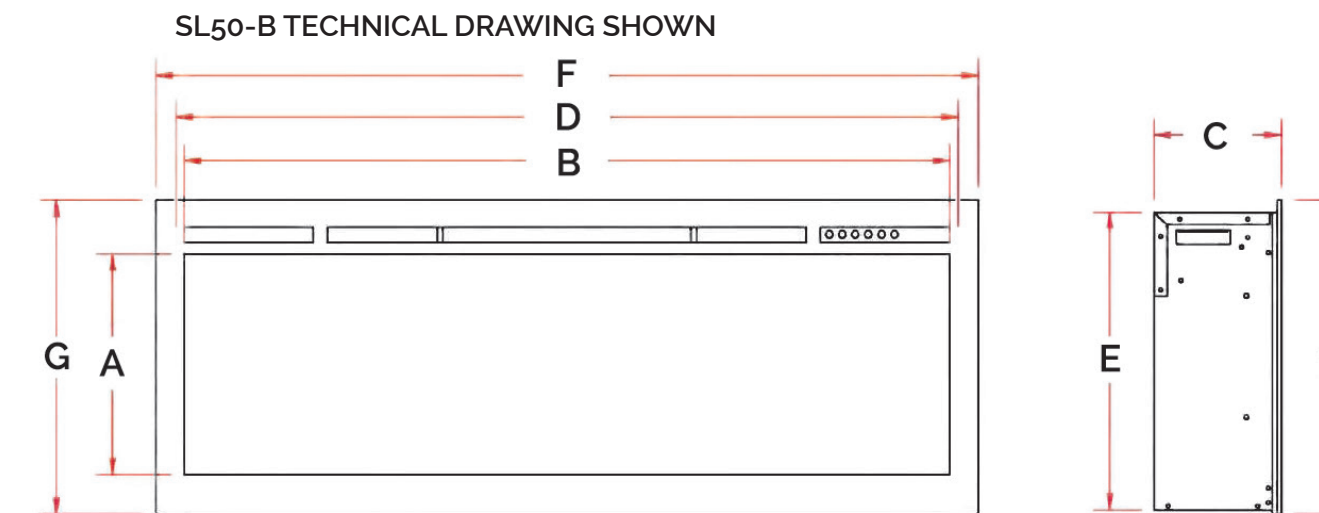

REMOTE CONTROL
Separate controls for on/off variable heat and variable flame.



SC36-B

SPECTRUM CONVENTIONAL SERIES













Electric Fireplace Built-in Flush Mount

Modern Flames Conventional Spectrum Series Built-In Flush Mount Electric Fireplace brings flame versatility with 12 different flame color combinations to choose from. A gray back screen allows the colors to shimmer and shine, dancing off multicolor glacier diamond glass, creating a crisp, clean flame and contemporary look along with our realistic Driftwood Logs. The Spectrum Conventional Series is available in a 36" wide model. A thermostat, touch control and remote completes this innovative series.



SC36-B

STANDARD FEATURES

-  Unsurpassed Realistic Flame Pattern
-  12 Color Flame Combinations
-  Canyon Driftwood Log Set
-  Glacier Glass Ember Bed
-  Low Energy LED Flame Technology
-  Touch Button Controls
-  New Sleek Remote
-  Can be Installed Beneath a TV
-  Variable Heat with Thermostat
-  Variable Flame Controls
-  120 Volt Plug/Hard Wire Ready
-  Do it Yourself Installation Instructions

SPECTRUM CONVENTIONAL SERIES

12 Flame Color Combinations at the Push of a Button

The 6 button control panel is located at the top right of fireplace including the digital readout thermostat. Button #1 turns the fireplace on or off. Button #2 turns on the heater. Button #3 turns the heater temperature up and #4 turns the heat down. Button #5 cycles through the 12 different flame color combinations, and button #6 adjusts the flame intensity.



Blue



Cyan



Emerald



Gold



Green



Ice Blue



Magenta



Multi



Orange



Purple



Red



White

SPECTRUM SERIES

Technical Specs - Conventional



REMOTE CONTROL
Separate controls for on/off variable heat and variable flame.

MODEL #	VOLTS	WATTS	BTU's	FRAMING (FINISHED OPENING)	INSTALLATION TYPE
SC36-B	AC 120V / 60Hz	1,530	5,000	35 1/2" L x 24 1/4" H x 8" D	Fully Recessed

SC36-B DIMENSIONS

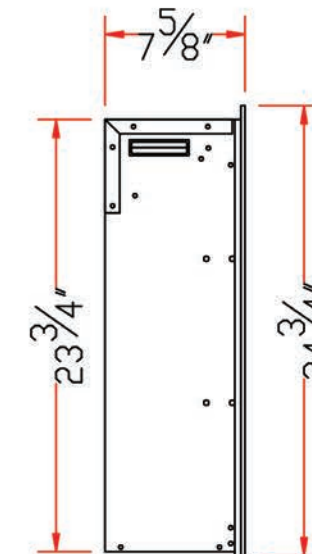
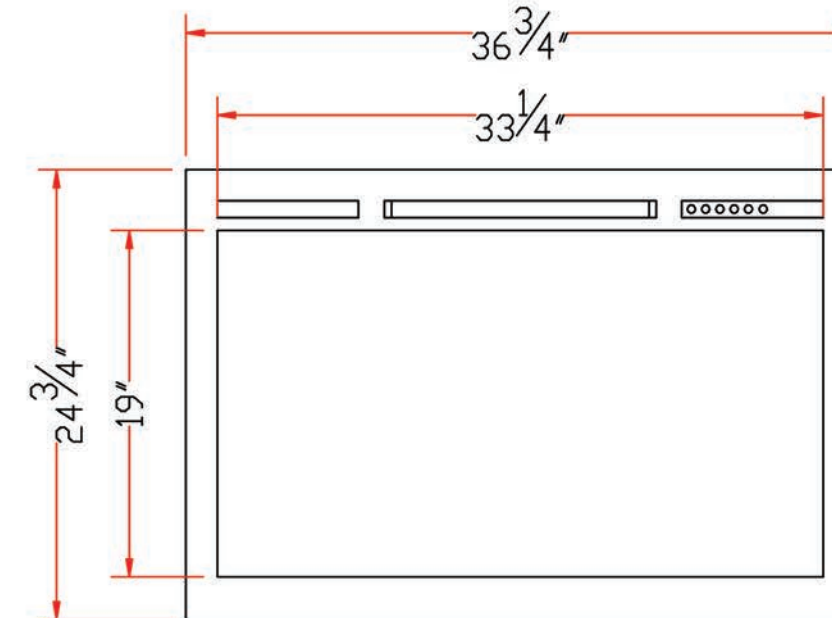













SEDONA SERIES

Built-in Flush Mount Electric Fireplaces

The Sedona 36" flush mount electric fireplace has the versatility of a contemporary acrylic glass or traditional authentic LED log set that looks extremely realistic whether it's on or off. This handsomely styled electric fireplace will make you proud to show your friends. The larger 42" size has an exceptional viewing area making this models one of a kind in the marketplace. The versatility of a single model can tailor to the room décor by a contemporary glass or traditional log appearance. The design of these models is built to gas fireplace specifications and provides a perfect substitute for such applications while providing supplemental heat up to 450 square feet.



STANDARD FEATURES

-  Low Energy LED Flame Technology
-  Flame Operates With or Without Heat
-  1500 Watt / 5000 BTU Heater
-  Can be Installed Beneath a TV
-  Deeper Firebox for 3D Burner & Flame
-  Designed to Match Standard Gas Fireplace Sizes
-  Customizable Side Panel Options
-  Media Bed Down Lighting
-  Hard Wire or Plug-in Cord Option
-  Touch Screen and Remote Control

SEDONA SERIES

Traditional or Contemporary

STANDARD FEATURES



Standard Sedona Firebox with Canyon Driftwood Logs & Herringbone Brick Side Panels

UPGRADE OPTION



Upgrade: Contemporary Glacier Kit & Black Glass Side Panels

EMBER BED WITH CHANGEABLE COLORS - Shown Below with Upgrade Contemporary Glacier Kit



Multiple Ember Bed Colors - 4 Colors Shown



SEDONA SERIES

Technical Specs



REMOTE CONTROL

Separate controls for on/off variable heat and variable flame.

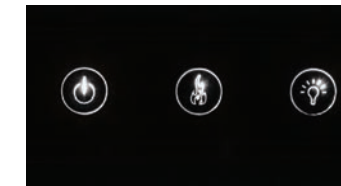

TOUCH SCREEN TECHNOLOGY

Directly above the flame on the right hand side you will find a series of touch controls. The 3 icons (in order) operate the power, heat (on/off) and light intensity. All touch controls fade to black after 4 seconds.

SEDONA FRAMING DIMENSIONS

MODEL #	Framing Dimensions(WxHxD)
SDF-36C	35 3/4"W x 25"H x 12"D
SDF-42C	41 1/2"W x 29"H x 14"D

SEDONA 36" DIMENSIONAL DRAWING

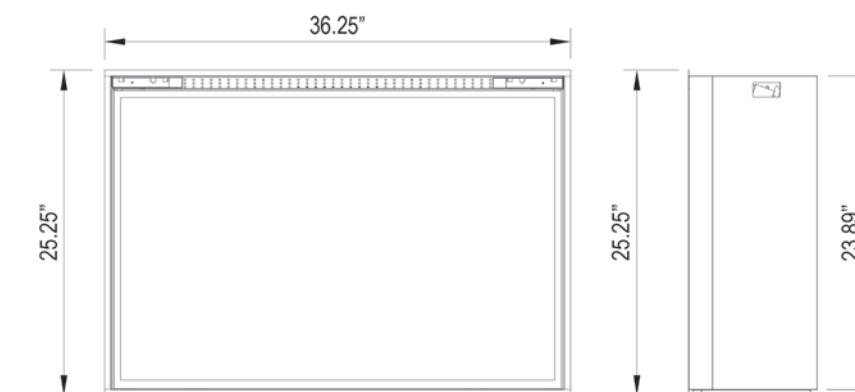

SEDONA 42" DIMENSIONAL DRAWING

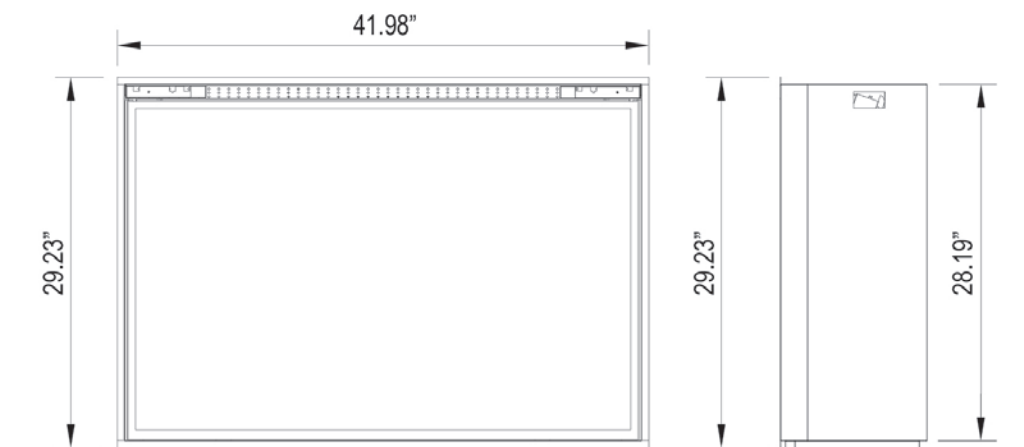



SCO-26

SUNSET CHARRED OAK LOGS

Electric Log Set

The Sunset Charred Oak Electric Logs set is the industry's first battery-powered and Wi-Fi-enabled electric log set. This electric log set is designed to simply be unpackaged and installed into any existing wood-burning fireplace without the hassle of running an electrical line. The Sunset Charred Oak features high-definition resin log detail, unsurpassed bark detail, 8-color paint scheme, realistic LED ember bed, 6-stage lighting intensity and flame settings, hidden manual controls, and Wi-Fi capability. Never has it been easier to add a full-featured electric log set to your wood-burning fireplace.











HIGH DEFINITION RESIN LOG & BARK DETAIL



OPTIONAL BATTERY PACK & CHARGER (10 hours of use)



STANDARD FEATURES

-  High Definition Resin Log Detail
-  8 Color Log Paint Scheme
-  Realistic LED Ember Bed
-  6 Stage Lighting Intensity
-  Natural Flame Pattern
-  Hidden Manual Controls
-  Optional Lithium Ion Battery Pack
-  Wi-Fi Capability



SCO-20

26" LOG DIMENSIONS:
12.25" Height
25.5" Width
13.5" Depth

20" LOG SET ALSO AVAILABLE
20" LOG DIMENSIONS:
10" Height
19.5" Width
10" Depth



ZCR2 INSERT

Electric Fireplace Insert

The ZCR2 Series is specifically designed to insert into an existing 30" – 42" wood burning fireplace and provide a beautiful and economical substitute to a gas log set or gas insert. Simply run power to your fireplace & insert the ZCR2 into the firebox without the need of screws or attaching hardware. The ZCR2 comes standard with new canyon driftwood logs & contemporary glacier glass for a traditional or contemporary look. A standard 4800 BTU heater & touch screen controls with a remote are all included. Finish off the ZCR2 with one of five different trim options to fit a plethora of unique firebox openings.



REMOTE CONTROL
Separate controls for on/off variable heat and variable flame.

OPTIONAL TRIM KITS



Trim Kit: TK-ZCR2-3222



Trim Kit: TK-ZCR2-3824



Trim Kit: TK-ZCR2-4326

ZCR2 DIMENSIONS

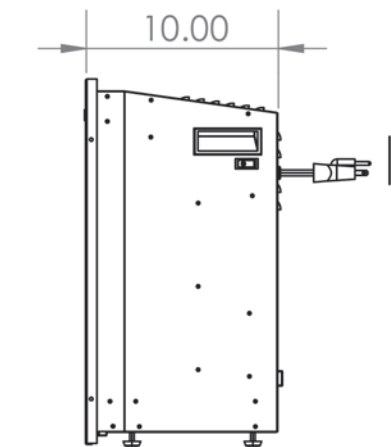
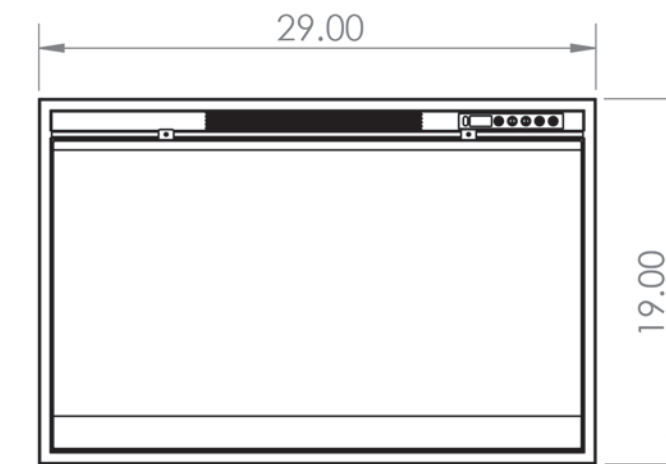

STANDARD FEATURES

- Realistic Flame Appearance
- Easy Access Push Button controls
- 1400 Watt /4800 BTU Heater
- Fits into Existing Zc Fireboxes
- Glowing LED Canyon Juniper Log Set
- 3 Stage Flame Brightness
- Can be Installed Beneath a TV
- Remote Control

MODERN FLAMES

ModernFlames.com

3515 E. Atlanta Ave. Phoenix, AZ 85040
(602) 268-9353 • (877) 246-9353



INNOVATING THE INDUSTRY STANDARDS OF TOMORROW